

Sphercial Roller Bearing

d1 240-320mm-23252CCK/W33+AOH2352G

参数信息:

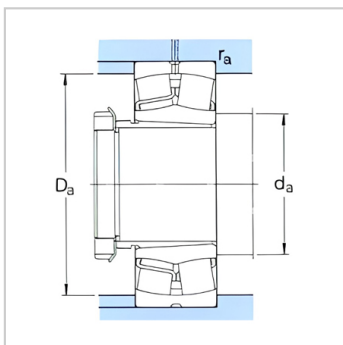
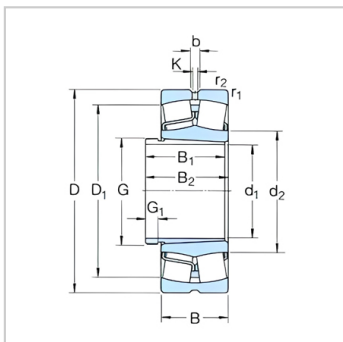

Principal dimensions (mm) :

d :	240
D :	480
B :	174

Basic load ratingsKN :

dycCr :	3250
stcCor :	4750
Pu :	360

Speed ratingsrpm :

Speed Ratings :	850
Limiting Speed :	1200
Bearing+ Withdrawal sleeves :	155

Designation :

Bearing :	23252CC K/W33
Withdrawal sleeves :	AOH2352 G

Dimensions mm :

d :	240
d ~ :	312
D1 ~ :	408
B :	205
B :	213
G :	Tr280 × 4
G :	30
b :	22.3
k :	12
rMin :	5

Abutment and fillet
dimensions mm :

dMax :	280
Da Max :	460
r Max :	4

Value :

e :	0.35
Y1 :	1.9
Y2 :	2.9
Yo :	1.8

: